

## Typ

## Typ 712/7010

Kolano kolnierzowe  
ze stopką N  
DN 80-600  
PN 10/16  
GGG

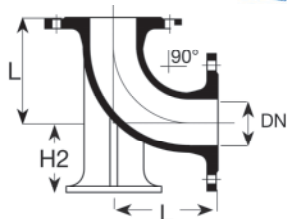

Nr katalogowy	DN mm	L mm	H2 mm	PN bar	Waga kg	Cena PLN
712-0080-70101	80	165	110	10/16	13,0	231,00
712-0100-70101	100	180	125	10/16	16,8	290,00
712-0125-70101	125	200	140	10/16	22,0	440,00
712-0150-70101	150	220	160	10/16	29,5	526,00
712-0200-70100	200	260	190	10	46,0	810,00
712-0250-70100	250	350	225	10	73,5	1 686,00
712-0300-70100	300	400	255	10	104,0	2 418,00
712-0350-70100	350	450	290	10	137,0	3 351,00
712-0400-70100	400	500	320	10	178,0	4 468,00
712-0500-70100	500	600	385	10	286,0	7 341,00
712-0600-70100	600	700	450	10	432,0	11 444,00

Uwaga: wersja PN 16 powyżej DN 150 na zapytanie.

## Typ 712/0610

Kolano dwukolnierzowe Q  
DN 50-700  
PN 10/16  
GGG

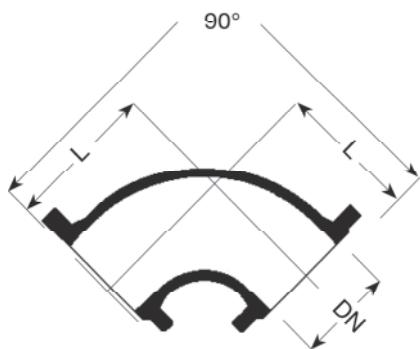

712-0050-06101	50	150		10/16	8,0	156,00
712-0065-06101	65	165		10/16	10,0	202,00
712-0080-06101	80	165		10/16	9,5	167,00
712-0100-06101	100	180		10/16	11,9	232,00
712-0125-06101	125	200		10/16	15,6	297,00
712-0150-06101	150	220		10/16	20,5	393,00
712-0200-06100	200	260		10	31,0	587,00
712-0250-06100	250	350		10	50,0	1 047,00
712-0300-06100	300	400		10	70,0	1 242,00
712-0350-06100	350	450		10	90,5	2 301,00
712-0400-06100	400	500		10	116,5	2 947,00
712-0450-06100	450	550		10	148,5	3 847,00
712-0500-06100	500	600		10	184,0	5 059,00
712-0600-06100	600	700		10	276,0	7 797,00
712-0700-06100	700	800		10	596,0	10 827,00

Uwaga: wersja PN 16 powyżej DN 150 na zapytanie.

## Typ 712/7512

Króciec jednokolnierzowy F-KS  
do rur PVC,  
DN 50-300  
PN 10/16  
GGG

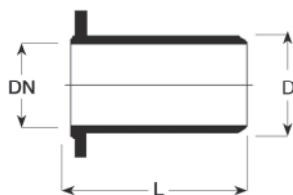

			D mm			
712-0050-75121	50	93	63	10/16	3,8	112,00
712-0065-75121	65	98	75	10/16	5,0	117,00
712-0080-75121	80	102	90	10/16	5,0	113,00
712-0100-75121	100	110	110	10/16	7,0	151,00
712-0150-75121	150	127	160	10/16	10,0	207,00
712-0200-75120	200	133	200	10	14,5	306,00
712-0225-75120	200	139	225	10	17,0	358,00
712-0250-75120	250	152	250	10	25,0	531,00
712-0280-75120	250	166	280	10	27,8	590,00
712-0300-75120	300	176	315	10	37,0	748,00

Uwaga: wersja PN 16 powyżej DN 150 na zapytanie.

## Typ

## Typ 712/1010

Trójnik kotłowy T  
 DN 50-800  
 PN 10/16  
 GGG

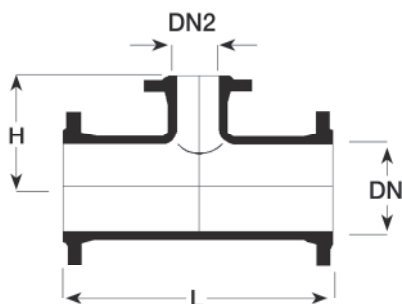

Nr katalogowy	DN mm	DN2 mm	L mm	H mm	PN bar	Waga kg	Cena PLN
712-0050-10101	50	50	300	150	10/16	12,0	236,00
712-0082-10101	80	50	330	160	10/16	15,0	246,00
712-0081-10101	80	65	330	160	10/16	16,0	284,00
712-0080-10101	80	80	330	165	10/16	16,0	264,00
712-0103-10101	100	50	360	170	10/16	18,0	315,00
712-0102-10101	100	65	360	170	10/16	19,0	338,00
712-0101-10101	100	80	360	175	10/16	19,0	305,00
712-0100-10101	100	100	360	180	10/16	20,0	310,00
712-0127-10101	125	80	400	190	10/16	23,0	377,00
712-0126-10101	125	100	400	195	10/16	24,0	449,00
712-0125-10101	125	125	400	200	10/16	25,5	475,00
712-0155-10101	150	50	440	200	10/16	27,5	550,00
712-0153-10101	150	80	440	205	10/16	28,5	469,00
712-0152-10101	150	100	440	210	10/16	29,5	465,00
712-0151-10101	150	125	440	215	10/16	31,0	550,00
712-0150-10101	150	150	440	220	10/16	32,0	528,00
712-0205-10100	200	50	520	230	10	40,7	1 063,00
712-0204-10100	200	80	520	235	10	42,0	676,00
712-0203-10100	200	100	520	240	10	43,0	707,00
712-0202-10100	200	125	520	245	10	46,0	904,00
712-0201-10100	200	150	520	250	10	46,5	763,00
712-0200-10100	200	200	520	260	10	50,0	791,00
712-0255-10100	250	80	700	265	10	67,5	1 157,00
712-0254-10100	250	100	700	275	10	68,0	1 161,00
712-0253-10100	250	125	700	280	10	75,0	1 630,00
712-0252-10100	250	150	700	300	10	81,0	1 303,00
712-0251-10100	250	200	700	325	10	76,5	1 383,00
712-0250-10100	250	250	700	350	10	83,0	1 349,00
712-0306-10100	300	80	800	290	10	93,5	1 734,00
712-0305-10100	300	100	800	300	10	94,0	1 555,00
712-0303-10100	300	150	800	325	10	101,0	1 596,00
712-0302-10100	300	200	800	350	10	102,0	1 625,00
712-0301-10100	300	250	800	375	10	114,0	1 984,00
712-0300-10100	300	300	800	400	10	117,0	1 759,00
712-0357-10100	350	80	850	325	10	130,0	2 739,00
712-0356-10100	350	100	850	325	10	117,0	2 788,00
712-0354-10100	350	150	850	325	10	135,0	2 822,00
712-0353-10100	350	200	850	325	10	137,7	2 954,00
712-0352-10100	350	250	850	325	10	137,7	2 650,00
712-0349-10100	350	300	850	425	10	154,4	4 592,00
712-0350-10100	350	350	850	425	10	150,6	3 492,00
712-0408-10100	400	80	900	350	10	167,4	3 470,00
712-0407-10100	400	100	900	350	10	170,6	3 512,00
712-0405-10100	400	150	900	350	10	157,0	3 241,00
712-0404-10100	400	200	900	350	10	150,0	3 325,00
712-0403-10100	400	250	900	350	10	175,0	5 252,00
712-0402-10100	400	300	900	450	10	160,0	3 701,00
712-0400-10100	400	400	900	450	10	177,0	4 055,00
712-0509-10100	500	100	1000	400	10	213,0	5 194,00
712-0507-10100	500	150	1000	400	10	243,5	5 219,00
712-0506-10100	500	200	1000	400	10	260,3	5 293,00
712-0504-10100	500	300	1000	500	10	277,0	5 833,00
712-0503-10100	500	350	1000	500	10	295,0	8 353,00
712-0502-10100	500	400	1000	500	10	244,0	5 960,00
712-0500-10100	500	500	1000	500	10	256,0	6 354,00
712-0610-10100	600	100	1100	450	10	310,0	8 027,00
712-0608-10100	600	150	1100	450	10	312,0	7 923,00
712-0607-10100	600	200	1100	450	10	309,0	7 548,00
712-0606-10100	600	250	1100	450	10	316,0	9 671,00
712-0605-10100	600	300	1100	550	10	321,0	7 963,00
712-0603-10100	600	400	1100	550	10	334,0	7 767,00
712-0601-10100	600	500	1100	550	10	351,0	8 019,00
712-0600-10100	600	600	1100	550	10	361,0	8 833,00
712-0708-10100	700	200	650	525	10	285,0	6 741,00
712-0704-10100	700	400	870	555	10	366,0	10 348,00
712-0700-10100	700	700	1200	600	10	510,0	14 959,00
712-0808-10100	800	200	690	585	10	468,0	15 272,00

Uwaga: wersja PN 16 powyżej DN 150 na zapytanie.

## Typ

## Typ 712/1510

Czwórnik kołnierzowy TT  
 DN 50-400  
 PN 10/16  
 GGG

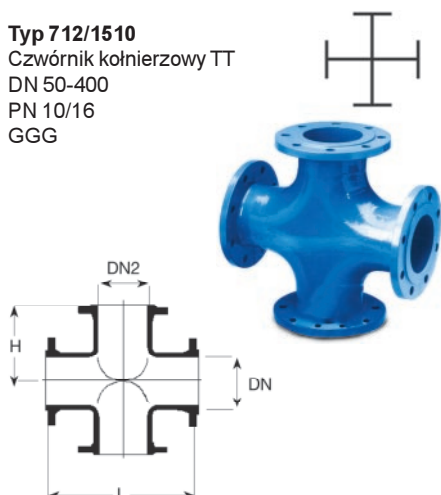

Nr katalogowy	DN mm	DN2 mm	L mm	H2 mm	PN bar	Waga kg	Cena PLN
712-0050-15101	50	50	300	150	10/16	17,0	na zapytanie
712-0080-15101	80	80	330	165	10/16	20,0	456,00
712-0100-15101	100	100	360	180	10/16	25,0	551,00
712-0125-15101	125	125	400	200	10/16	35,0	596,00
712-0150-15101	150	150	440	220	10/16	41,5	733,00
712-0200-15100	200	200	520	260	10	62,5	1 224,00
712-0300-15100	300	300	800	400	10	145,0	3 597,00
712-0400-15100	400	400	900	450	10	298,0	5 211,00

Uwaga: wersja PN 16 powyżej DN 150 na zapytanie.

## Typ 712/2210

Zwężka dwukolnierzowa FFR  
 DN 65-700  
 PN 10/16  
 GGG

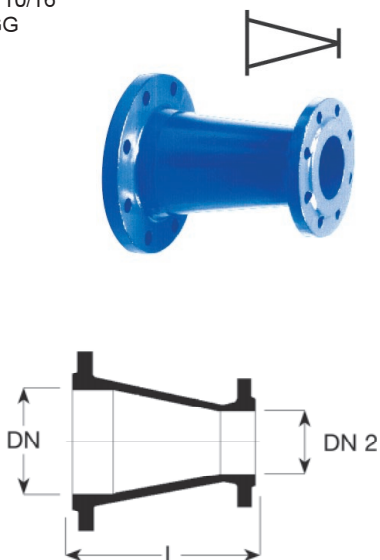

712-0066-22101	65	50	200		10/16	6,8	166,00
712-0082-22101	80	50	200		10/16	7,2	149,00
712-0081-22101	80	65	200		10/16	8,2	161,00
712-0103-22101	100	50	200		10/16	8,1	167,00
712-0102-22101	100	65	200		10/16	8,8	194,00
712-0101-22101	100	80	200		10/16	9,3	171,00
712-0127-22101	125	80	200		10/16	10,5	214,00
712-0126-22101	125	100	200		10/16	11,4	227,00
712-0153-22101	150	80	200		10/16	12,0	250,00
712-0152-22101	150	100	200		10/16	12,8	254,00
712-0151-22101	150	125	200		10/16	14,1	281,00
712-0204-22100	200	80	300		10	17,7	349,00
712-0203-22100	200	100	300		10	18,6	359,00
712-0202-22100	200	125	300		10	20,0	387,00
712-0201-22100	200	150	300		10	22,0	420,00
712-0255-22100	250	80	300		10	23,0	622,00
712-0254-22100	250	100	300		10	24,0	648,00
712-0252-22100	250	150	300		10	27,0	665,00
712-0251-22100	250	200	300		10	30,5	681,00
712-0305-22100	300	100	300		10	29,5	779,00
712-0303-22100	300	150	300		10	32,5	846,00
712-0302-22100	300	200	300		10	35,5	765,00
712-0301-22100	300	250	300		10	41,0	872,00
712-0353-22100	350	200	300		10	45,0	1 452,00
712-0352-22100	350	250	300		10	45,0	1 472,00
712-0349-22100	350	300	300		10	50,0	1 142,00
712-0406-22100	400	100	300		10	68,2	1 499,00
712-0404-22100	400	150	300		10	74,8	1 644,00
712-0404-22100	400	200	300		10	74,0	1 626,00
712-0403-22100	400	250	300		10	50,5	1 303,00
712-0402-22100	400	300	300		10	55,0	1 385,00
712-0401-22100	400	350	300		10	59,5	1 546,00
712-0454-22100	450	250	300		10	88,0	2 030,00
712-0453-22100	450	300	300		10	65,0	2 191,00
712-0452-22100	450	350	300		10	71,0	2 399,00
712-0505-22100	500	250	600		10	114,0	2 724,00
712-0503-22100	500	350	600		10	102,0	3 249,00
712-0502-22100	500	400	600		10	110,0	2 999,00
712-0603-22100	600	400	600		10	135,0	3 783,00
712-0602-22100	600	450	600		10	143,0	4 036,00
712-0601-22100	600	500	600		10	149,0	4 645,00
712-0701-22100	700	600	600		10	200,0	7 742,00

Uwaga: wersja PN 16 powyżej DN 150 na zapytanie.

## Typ

## Typ 712/0110

Łuk dwukołnierowy FFK 11°  
DN 80-600  
PN 10/16  
GGG

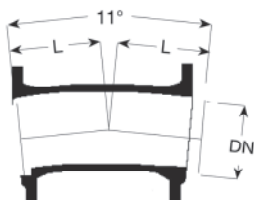

Nr katalogowy	DN mm	L mm	PN bar	Waga kg	Cena PLN
712-0080-01101	80	113	10/16	15,0	183,00
712-0100-01101	100	115	10/16	19,0	216,00
712-0150-01101	150	113	10/16	34,0	342,00
712-0200-01100	200	132	10	48,0	529,00
712-0250-01100	250	165	10	57,0	932,00
712-0300-01100	300	175	10	80,0	1 278,00
712-0350-01100	350	191	10	68,0	1 700,00
712-0400-01100	400	205	10	82,0	2 388,00
712-0500-01100	500	135	10	115,0	4 161,00
712-0600-01100	600	174	10	157,0	4 466,00

Uwaga: wersja PN 16 powyżej DN 150 na zapytanie.

## Typ 712/0210

Łuk dwukołnierowy FFK 22°  
DN 80-600  
PN 10/16  
GGG

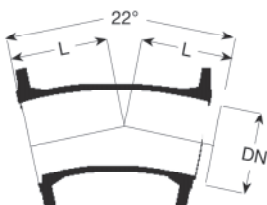

712-0080-02101	80	105	10/16	15,0	183,00
712-0100-02101	100	110	10/16	19,0	214,00
712-0150-02101	150	109	10/16	24,0	348,00
712-0200-02100	200	131	10	48,0	494,00
712-0250-02100	250	190	10	57,0	961,00
712-0300-02100	300	210	10	80,0	1 246,00
712-0350-02100	350	210	10	82,0	1 715,00
712-0400-02100	400	239	10	85,0	1 801,00
712-0500-02100	500	185	10	131,0	3 792,00
712-0600-02100	600	254	10	189,0	5 095,00

Uwaga: wersja PN 16 powyżej DN 150 na zapytanie.

## Typ 712/0310

Łuk dwukołnierowy FFK 30°  
DN 80-600  
PN 10/16  
GGG

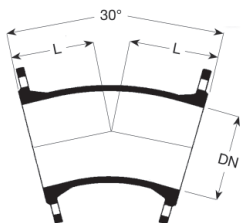

712-0080-03101	80	130	10/16	15,0	193,00
712-0100-03101	100	140	10/16	19,0	224,00
712-0150-03101	150	160	10/16	34,0	356,00
712-0200-03100	200	180	10	48,0	519,00
712-0250-03100	250	210	10	57,0	1 014,00
712-0300-03100	300	255	10	80,0	1 302,00
712-0350-03100	350	217	10	85,0	1 613,00
712-0400-03100	400	324	10	87,0	2 687,00
712-0500-03100	500	273	10	167,0	3 664,00
712-0600-03100	600	279	10	212,0	6 350,00

Uwaga: wersja PN 16 powyżej DN 150 na zapytanie.

## Typ 712/0410

Łuk dwukołnierowy FFK 45°  
DN 80-700  
PN 10/16  
GGG

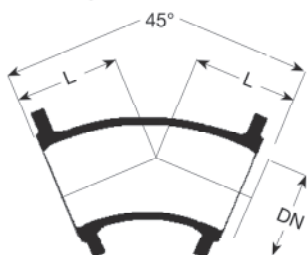

712-0080-04101	80	130	10/16	9,1	187,00
712-0100-04101	100	140	10/16	11,4	221,00
712-0125-04101	125	150	10/16	14,6	278,00
712-0150-04101	150	160	10/16	18,7	349,00
712-0200-04100	200	180	10	27,5	509,00
712-0250-04100	250	350	10	55,0	1 181,00
712-0300-04100	300	400	10	78,0	1 610,00
712-0350-04100	350	298	10	76,0	1 965,00
712-0400-04100	400	324	10	96,0	2 551,00
712-0500-04100	500	375	10	145,0	3 374,00
712-0600-04100	600	426	10	212,0	5 252,00
712-0700-04100	700	478	10	341,0	8 575,00

Uwaga: wersja PN 16 powyżej DN 150 na zapytanie.

## Typ

**Typ 712/4010**

Króciec dwukołnierzowy FF  
 DN 50-300  
 PN 10/16  
 GGG

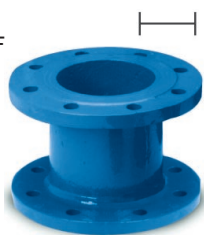

Nr katalogowy	DN mm	L mm	PN bar	Waga kg	Cena PLN
712-0050-40101	50	100	10/16	5,2	96,00
712-0065-40101	65	100	10/16	6,2	116,00
712-0080-40101	80	100	10/16	7,4	143,00
712-0100-40101	100	100	10/16	8,7	161,00
712-0125-40101	125	100	10/16	10,7	188,00
712-0150-40101	150	100	10/16	13,1	245,00
712-0200-40100	200	100	10	18,2	323,00
712-0250-40100	250	100	10	26,4	449,00
712-0300-40100	300	100	10	33,8	602,00

**Uwaga:** wersja PN 16 powyżej DN 150 na zapytanie.

**Typ 712/4110**

Króciec dwukołnierzowy FF  
 DN 80-200  
 PN 10/16  
 GGG

712-0080-41101	80	150	10/16	8,5	154,00
712-0100-41101	100	150	10/16	9,8	187,00
712-0200-41100	200	150	10	18,8	360,00

**Uwaga:** wersja PN 16 powyżej DN 150 na zapytanie.

**Typ 712/4210**

Króciec dwukołnierzowy FF  
 DN 50-600  
 PN 10/16  
 GGG

712-0050-42101	50	200	10/16	6,1	114,00
712-0080-42101	80	200	10/16	9,1	159,00
712-0100-42101	100	200	10/16	10,7	205,00
712-0125-42101	125	200	10/16	13,3	248,00
712-0150-42101	150	200	10/16	16,3	311,00
712-0200-42100	200	200	10	22,8	430,00
712-0250-42100	250	200	10	31,5	731,00
712-0300-42100	300	200	10	41,6	800,00
712-0350-42100	350	200	10	47,3	na zapytanie
712-0400-42100	400	200	10	54,3	1 797,00
712-0500-42100	500	200	10	78,1	na zapytanie
712-0600-42100	600	200	10	104,3	na zapytanie

**Uwaga:** wersja PN 16 powyżej DN 150 na zapytanie.

**Typ 712/4310**

Króciec dwukołnierzowy FF  
 DN 80-300  
 PN 10/16  
 GGG

712-0080-43101	80	250	10/16	10,2	192,00
712-0100-43101	100	250	10/16	11,7	235,00
712-0150-43101	150	250	10/16	15,9	347,00
712-0300-43100	300	250	10	45,0	826,00

**Uwaga:** wersja PN 16 powyżej DN 150 na zapytanie.

**Typ 712/4410**

Króciec dwukołnierzowy FF  
 DN 50-700  
 PN 10/16  
 GGG

712-0050-44101	50	300	10/16	9,0	135,00
712-0065-44101	65	300	10/16	8,8	163,00
712-0080-44101	80	300	10/16	10,6	179,00
712-0100-44101	100	300	10/16	12,7	240,00
712-0125-44101	125	300	10/16	15,9	294,00
712-0150-44101	150	300	10/16	19,5	322,00
712-0200-44100	200	300	10	27,5	512,00
712-0250-44100	250	300	10	37,6	770,00
712-0300-44100	300	300	10	49,5	898,00
712-0350-44100	350	300	10	57,0	1 396,00
712-0400-44100	400	300	10	65,5	1 748,00
712-0500-44100	500	300	10	94,2	2 247,00
712-0600-44100	600	300	10	125,4	3 054,00
712-0700-44100	700	300	10	158,5	3 945,00

**Uwaga:** wersja PN 16 powyżej DN 150 na zapytanie.

**Typ 712/4510**

Króciec dwukołnierzowy FF  
 DN 150-200  
 PN 10/16  
 GGG

712-0150-45101	150	350	10/16	21,0	391,00
712-0200-45100	200	350	10	30,0	551,00

**Uwaga:** wersja PN 16 powyżej DN 150 na zapytanie.

## Typ

**Typ 712/4610**

Króciec dwukołnierzowy FF  
DN 50-600  
PN 10/16  
GGG

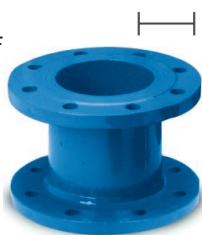

Nr katalogowy	DN mm	L mm	PN bar	Waga kg	Cena PLN
712-0050-46101	50	400	10/16	10,0	151,00
712-0065-46101	65	400	10/16	13,0	188,00
712-0080-46101	80	400	10/16	12,3	204,00
712-0100-46101	100	400	10/16	14,8	270,00
712-0125-46101	125	400	10/16	18,6	340,00
712-0150-46101	150	400	10/16	22,8	413,00
712-0200-46100	200	400	10	32,1	592,00
712-0250-46100	250	400	10	43,7	798,00
712-0300-46100	300	400	10	57,3	1 045,00
712-0350-46100	350	400	10	66,6	1 632,00
712-0400-46100	400	400	10	76,6	1 975,00
712-0500-46100	500	400	10	100,3	2 639,00
712-0600-46100	600	400	10	146,6	3 579,00

**Uwaga:** wersja PN 16 powyżej DN 150 na zapytanie.

**Typ 712/4810**

Króciec dwukołnierzowy FF  
DN 50-800  
PN 10/16  
GGG

712-0050-48101	50	500	10/16	11,0	170,00
712-0065-48101	65	500	10/16	14,5	212,00
712-0080-48101	80	500	10/16	13,9	228,00
712-0100-48101	100	500	10/16	16,8	278,00
712-0125-48101	125	500	10/16	21,2	396,00
712-0150-48101	150	500	10/16	26,0	477,00
712-0200-48100	200	500	10	36,7	970,00
712-0250-48100	250	500	10	49,9	922,00
712-0300-48100	300	500	10	65,1	1 244,00
712-0350-48100	350	500	10	76,3	1 864,00
712-0400-48100	400	500	10	87,7	2 687,00
712-0500-48100	500	500	10	126,3	3 037,00
712-0600-48100	600	500	10	167,7	4 094,00
712-0700-48100	700	500	10	210,1	5 257,00
712-0800-48100	800	500	10	270,4	6 741,00

**Uwaga:** wersja PN 16 powyżej DN 150 na zapytanie.

**Typ 712/4910**

Króciec dwukołnierzowy FF  
DN 50-700  
PN 10/16  
GGG

712-0050-49101	50	600	10/16	12,5	188,00
712-0065-49101	65	600	10/16	16,0	235,00
712-0080-49101	80	600	10/16	15,5	301,00
712-0100-49101	100	600	10/16	18,9	365,00
712-0125-49101	125	600	10/16	23,9	440,00
712-0150-49101	150	600	10/16	29,3	637,00
712-0200-49100	200	600	10	41,3	772,00
712-0250-49100	250	600	10	56,0	1 027,00
712-0300-49100	300	600	10	72,9	1 338,00
712-0350-49100	350	600	10	85,9	2 101,00
712-0400-49100	400	600	10	98,9	2 517,00
712-0500-49100	500	600	10	142,4	3 420,00
712-0600-49100	600	600	10	188,8	4 617,00
712-0700-49100	700	600	10	235,9	5 911,00

**Uwaga:** wersja PN 16 powyżej DN 150 na zapytanie.

**Typ 712/5010**

Króciec dwukołnierzowy FF  
DN 50-700  
PN 10/16  
GGG

712-0050-50101	50	700	10/16	11,2	207,00
712-0080-50101	80	700	10/16	17,1	353,00
712-0100-50101	100	700	10/16	20,9	432,00
712-0125-50101	125	700	10/16	26,5	486,00
712-0150-50101	150	700	10/16	32,5	600,00
712-0200-50100	200	700	10	45,9	843,00
712-0250-50100	250	700	10	62,1	1 136,00
712-0300-50100	300	700	10	80,7	1 475,00
712-0350-50100	350	700	10	95,6	2 346,00
712-0400-50100	400	700	10	110,0	2 785,00
712-0500-50100	500	700	10	148,5	3 823,00
712-0700-50100	600	700	10	209,9	5 130,00
712-0700-50100	700	700	10	261,7	6 571,00

**Uwaga:** wersja PN 16 powyżej DN 150 na zapytanie.

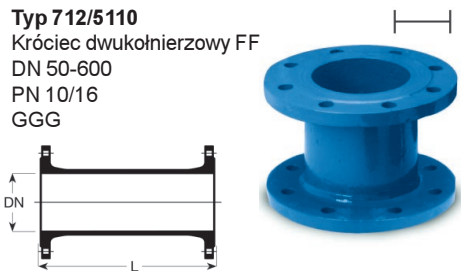
Typ		Nr katalogowy	DN mm	L mm	PN bar	Waga kg	Cena PLN	
<b>Typ 712/5110</b> Króciec dwukołnierzowy FF DN 50-600 PN 10/16 GGG		712-0050-51101	50	800	10/16	14,5	225,00	
		712-0065-51101	65	800	10/16	19,0	283,00	
		712-0080-51101	80	800	10/16	18,7	363,00	
		712-0100-51101	100	800	10/16	23,0	473,00	
		712-0125-51101	125	800	10/16	29,1	533,00	
		712-0150-51101	150	800	10/16	35,7	661,00	
		712-0200-51100	200	800	10	50,5	926,00	
		712-0250-51100	250	800	10	68,3	1 248,00	
		712-0300-51100	300	800	10	88,5	1 622,00	
		712-0350-51100	350	800	10	105,2	2 577,00	
		712-0400-51100	400	800	10	121,1	3 066,00	
		712-0500-51100	500	800	10	174,5	4 213,00	
		712-0600-51100	600	800	10	231,1	5 642,00	
		<b>Typ 712/5210</b> Króciec dwukołnierzowy FF DN 50-600 PN 10/16 GGG	712-0050-52101	50	900	10/16	13,1	241,00
			712-0065-52101	65	900	10/16	16,7	307,00
712-0080-52101	80		900	10/16	20,5	400,00		
712-0100-52101	100		900	10/16	25,0	514,00		
712-0125-52101	125		900	10/16	32,0	578,00		
712-0150-52101	150		900	10/16	39,0	715,00		
712-0200-52100	200		900	10	55,5	1 008,00		
712-0250-52100	250		900	10	75,0	1 357,00		
712-0300-52100	300		900	10	96,5	1 759,00		
712-0350-52100	350		900	10	116,0	2 809,00		
712-0400-52100	400		900	10	139,0	3 347,00		
712-0500-52100	500		900	10	191,0	4 592,00		
712-0600-52100	600		900	10	256,0	6 156,00		
<b>Typ 712/5310</b> Króciec dwukołnierzowy FF DN 50-700 PN 10/16 GGG	712-0050-53101	50	1000	10/16	16,5	259,00		
	712-0065-53101	65	1000	10/16	22,0	331,00		
	712-0080-53101	80	1000	10/16	21,9	427,00		
	712-0100-53101	100	1000	10/16	27,0	460,00		
	712-0125-53101	125	1000	10/16	34,4	641,00		
	712-0150-53101	150	1000	10/16	42,2	803,00		
	712-0200-53100	200	1000	10	60,0	1 105,00		
	712-0250-53100	250	1000	10	80,5	1 469,00		
	712-0300-53100	300	1000	10	104,1	1 931,00		
	712-0350-53100	350	1000	10	124,5	3 054,00		
	712-0400-53100	400	1000	10	143,4	3 639,00		
	712-0500-53100	500	1000	10	206,6	4 983,00		
	712-0600-53100	600	1000	10	273,3	6 668,00		
712-0700-53100	700	1000	10	339,2	8 536,00			
<b>Typ 712/5410</b> Króciec dwukołnierzowy FF DN 100 PN 10/16 GGG	712-0100-54101	100	1100	10/16	29,0	682,00		
<b>Typ 712/5510</b> Króciec dwukołnierzowy FF DN 100 PN 10/16 GGG	712-0100-55101	100	1200	10/16	31,1	729,00		
<b>Typ 712/5610</b> Króciec dwukołnierzowy FF DN 250-500 PN 10/16 GGG	712-0250-56100	250	1300	10	99,7	2 339,00		
	712-0400-56100	400	1300	10	184,0	5 243,00		
	712-0500-56100	500	1300	10	253,0	7 209,00		
<b>Typ 712/5710</b> Króciec dwukołnierzowy FF DN 200 PN 10/16 GGG	712-0200-57100	200	1400	10	78,5	1 842,00		

**Uwaga:** do wszystkich typów wersja PN 16 powyżej DN 150 na zapytanie.

## Typ

## Typ 712/5810

Króciec dwukołnierzowy FF  
DN 50-600  
PN 10/16  
GGG

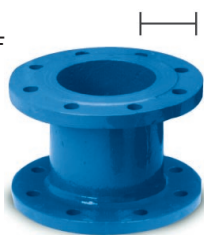

Nr katalogowy	DN mm	D mm	L mm	PN bar	Waga kg	Cena PLN
712-0050-58101	50	1500		10/16		na zapytanie
712-0065-58101	65	1500		10/16		na zapytanie
712-0080-58101	80	1500		10/16	30,1	708,00
712-0100-58101	100	1500		10/16	37,2	873,00
712-0125-58101	125	1500		10/16	47,6	1 117,00
712-0150-58101	150	1500		10/16	58,6	1 375,00
712-0200-58100	200	1500		10	83,1	1 950,00
712-0250-58100	250	1500		10	112,0	2 627,00
712-0300-58100	300	1500		10	143,0	3 353,00
712-0350-58100	350	1500		10	173,0	4 930,00
712-0400-58100	400	1500		10	207,0	5 898,00
712-0500-58100	500	1500		10	285,0	8 121,00
712-0600-58100	600	1500		10	379,0	10 799,00

Uwaga: wersja PN 16 powyżej DN 150 na zapytanie.

## Typ 712/6310

Króciec dwukołnierzowy FF  
DN 50-600  
PN 10/16  
GGG

712-0050-63101	50	2000		10/16		na zapytanie
712-0065-63101	65	2000		10/16		na zapytanie
712-0080-63101	80	2000		10/16	38,2	896,00
712-0100-63101	100	2000		10/16	47,4	1 113,00
712-0125-63101	125	2000		10/16		na zapytanie
712-0150-63101	150	2000		10/16	75,0	1 759,00
712-0200-63100	200	2000		10	106,0	2 486,00
712-0250-63100	250	2000		10	142,0	3 330,00
712-0300-63100	300	2000		10	182,0	4 268,00
712-0350-63100	350	2000		10		na zapytanie
712-0400-63100	400	2000		10	265,0	7 552,00
712-0500-63100	500	2000		10	365,0	10 400,00
712-0600-63100	600	2000		10	485,0	13 820,00

Uwaga: wersja PN 16 powyżej DN 150 na zapytanie.

## Typ 712/7513

Króciec jednokołnierzowy F  
DN 65-700  
PN 10/16  
GGG

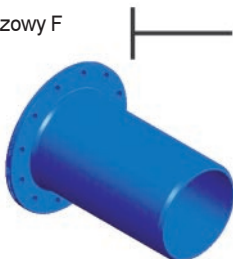
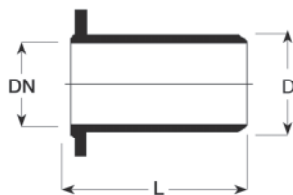

712-0065-75131	65	82	345	10/16	9,5	175,00
712-0080-75131	80	98	350	10/16	7,8	148,00
712-0100-75131	100	118	360	10/16	9,7	185,00
712-0125-75131	125	144	370	10/16	12,5	222,00
712-0150-75131	150	170	380	10/16	15,8	296,00
712-0200-75130	200	222	400	10	22,8	425,00
712-0250-75130	250	274	420	10	31,8	677,00
712-0300-75130	300	326	440	10	43,3	922,00
712-0350-75130	350	378	460	10	52,3	1 338,00
712-0400-75130	400	429	480	10	64,3	1 825,00
712-0500-75130	500	532	520	10	93,9	2 296,00
712-0600-75130	600	635	560	10	135,0	3 249,00
712-0700-75130	700	738	600	10	189,0	4 397,00

Uwaga: wersja PN 16 powyżej DN 150 na zapytanie.

## Typ 712/3810

Kołnierz ślepy X  
DN 80-600  
PN 10/16  
GGG

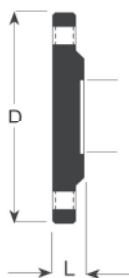

712-0080-38101	80	200	19	10/16	3,6	67,00
712-0100-38101	100	220	19	10/16	4,3	73,00
712-0125-38101	125	250	19	10/16	5,6	95,00
712-0150-38101	150	285	19	10/16	7,2	121,00
712-0200-38100	200	340	20	10	11,4	181,00
712-0250-38100	250	400	22	10	16,9	304,00
712-0300-38100	300	455	25	10	26,0	450,00
712-0350-38100	350	505	25	10	30,5	732,00
712-0400-38100	400	565	25	10	38,0	963,00
712-0500-38100	500	670	27	10	56,0	1 401,00
712-0600-38100	600	780	30	10	86,0	2 158,00

Uwaga: wersja PN 16 powyżej DN 150 na zapytanie.

## Typ

## Typ 712/8010

Trójnik kołnierzowy 45° FFC  
 DN 80-300  
 PN 10/16  
 GGG

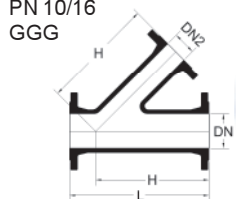

## Nr katalogowy

DN  
mmDN2  
mmL  
mmH  
mmPN  
barWaga  
kgCena  
PLN

712-0080-80101	80	80	500	375	10/16	21,0	508,00
712-0100-80101	100	100	540	405	10/16	27,0	662,00
712-0150-80101	150	150	640	480	10/16	47,0	926,00
712-0200-80100	200	200	735	560	10	71,0	1 609,00
712-0250-80100	250	250	830	640	10	105,0	2 247,00
712-0300-80100	300	300	930	715	10	147,0	4 031,00

Uwaga: wersja PN 16 powyżej DN 150 na zapytanie.

## Typ 712/8110

Trójnik kołnierzowy kierunkowy SCH  
 DN 80-400  
 PN 10/16  
 GGG

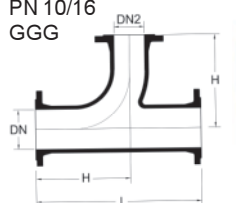

712-0080-81101	80	80	545	380	10/16	23,0	505,00
712-0100-81101	100	100	580	400	10/16	29,5	630,00
712-0150-81101	150	150	670	450	10/16	48,5	1 008,00
712-0200-81100	200	200	760	500	10	72,5	1 636,00
712-0250-81100	250	250	900	550	10	106,0	2 518,00
712-0300-81100	300	300	1000	600	10	146,0	3 398,00
712-0400-81100	400	400	1200	700	10	270,0	5 916,00

Uwaga: wersja PN 16 powyżej DN 150 na zapytanie.

## Typ 712/8210

Zwężka dwukołnierzowa acentryczna FFRe  
 DN 80-600  
 PN 10/16  
 GGG

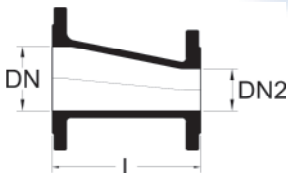

712-0082-82101	80	50	200		10/16	7,3	153,00
712-0081-82101	80	65	200		10/16	8,7	182,00
712-0103-82101	100	50	200		10/16	9,4	196,00
712-0101-82101	100	80	200		10/16	9,3	194,00
712-0153-82101	150	80	200		10/16	16,0	335,00
712-0152-82101	150	100	200		10/16	15,0	313,00
712-0204-82100	200	80	300		10	25,6	535,00
712-0203-82100	200	100	300		10	27,0	563,00
712-0201-82100	200	150	300		10	21,5	448,00
712-0252-82100	250	150	300		10	38,0	793,00
712-0251-82100	250	200	300		10	29,5	615,00
712-0305-82100	300	100	300		10	42,0	876,00
712-0303-82100	300	150	300		10	46,0	959,00
712-0302-82100	300	200	300		10	51,0	1 063,00
712-0301-82100	300	250	300		10	56,0	824,00
712-0353-82100	350	200	300		10	61,0	1 271,00
712-0403-82100	400	250	300		10	77,0	1 605,00
712-0402-82100	400	300	300		10	84,0	1 750,00
712-0453-82100	450	300	300		10	95,0	1 980,00
712-0451-82100	450	400	300		10	88,0	1 833,00
712-0505-82100	500	250	600		10	118,0	3 044,00
712-0502-82100	500	400	600		10	124,0	3 044,00
712-0603-82100	600	400	600		10	157,0	5 080,00
712-0602-82100	600	450	600		10	174,0	5 898,00
712-0601-82100	600	500	600		10	196,0	6 112,00

Uwaga: wersja PN 16 powyżej DN 150 na zapytanie.

## Typ 712/8310

Dyfuzor OMS  
 DN 80-700  
 PN 10/16  
 GGG

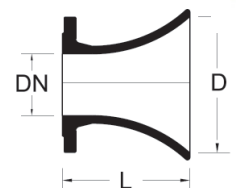

712-0080-83101	80	160	135		10/16	9,0	199,00
712-0100-83101	100	185	140		10/16	11,0	243,00
712-0150-83101	150	245	155		10/16	14,0	309,00
712-0200-83100	200	310	170		10	24,0	529,00
712-0250-83100	250	370	190		10	32,0	706,00
712-0300-83100	300	435	210		10	44,0	970,00
712-0350-83100	350	495	225		10	72,0	1 904,00
712-0400-83100	400	560	245		10	92,0	2 432,00
712-0450-83100	450	620	260		10	115,0	3 040,00
712-0500-83100	500	685	280		10	130,0	3 436,00
712-0600-83100	600	810	300		10	175,0	4 625,00
712-0700-83100	700	945	340		10	195,0	5 154,00

Uwaga: wersja PN 16 powyżej DN 150 na zapytanie.